

Data Sheet



Article number: 586142388

Description: Push-on fitting 14.238-8, metal $\text{Ø}8/6\text{-G } 3/8\text{'-Ø}8/6$
Banjo Tee

Measures

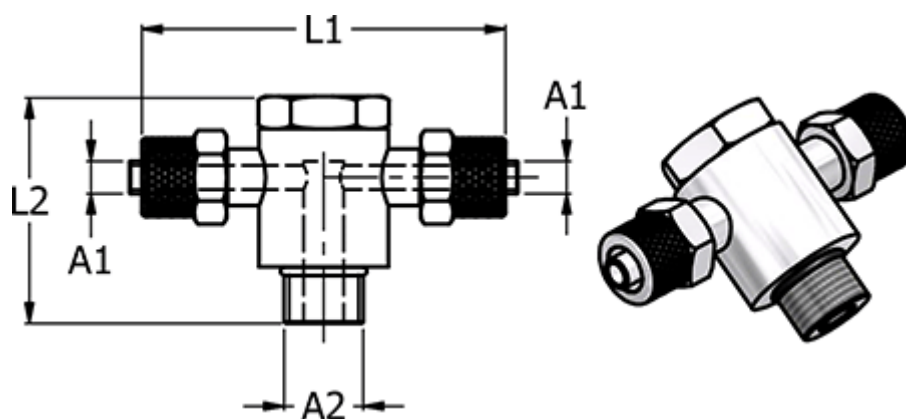

Hose diameter A1	= 8/6
L1	= 57.0
L2	= 37.0
NV	= 20
Thread A2	= G 3/8"